

8" Smart Valve Cut Sheet

Materials

- Stainless Steel
- Acetron GP
- FDA approved internal o-rings

Certifications

- NSF 61 (potable water)
- NSF 372 (lead free)
- Certifying laboratory: IAPMO R&T

Installation Dimensions

8" SMART VALVE:

- Body Length – Flange to Flange 12.16"
- Approximate Weight 95 lbs
- Bolt Pattern Standard
- Bolt Holes Through Holes
- Shipping Weight 100 lbs

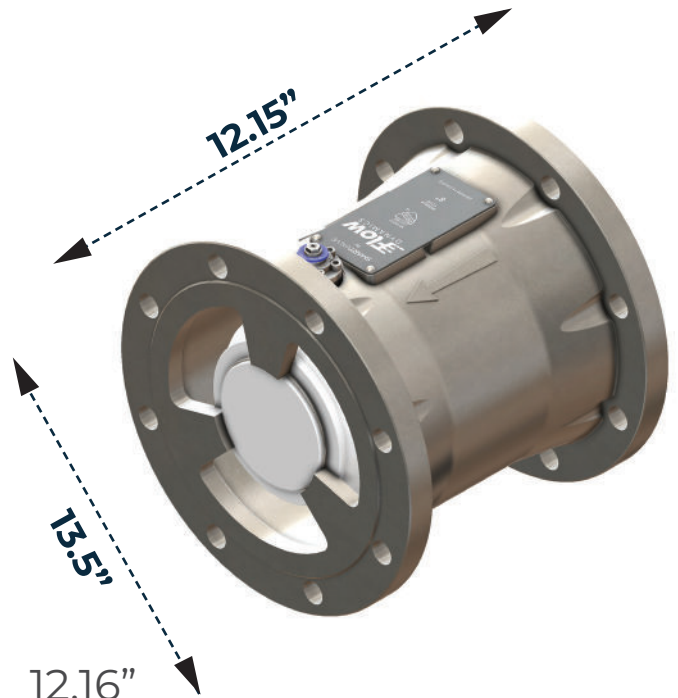

For best results install the Smart Valve downstream of water meter and backflow preventer (if present), but before any other equipment such as a pressure reducer or booster pump. Where possible it is recommended (but not critical) to have 10 diameters of pipe between the water meter and the valve. All flanged installations to use gaskets at each flange.